

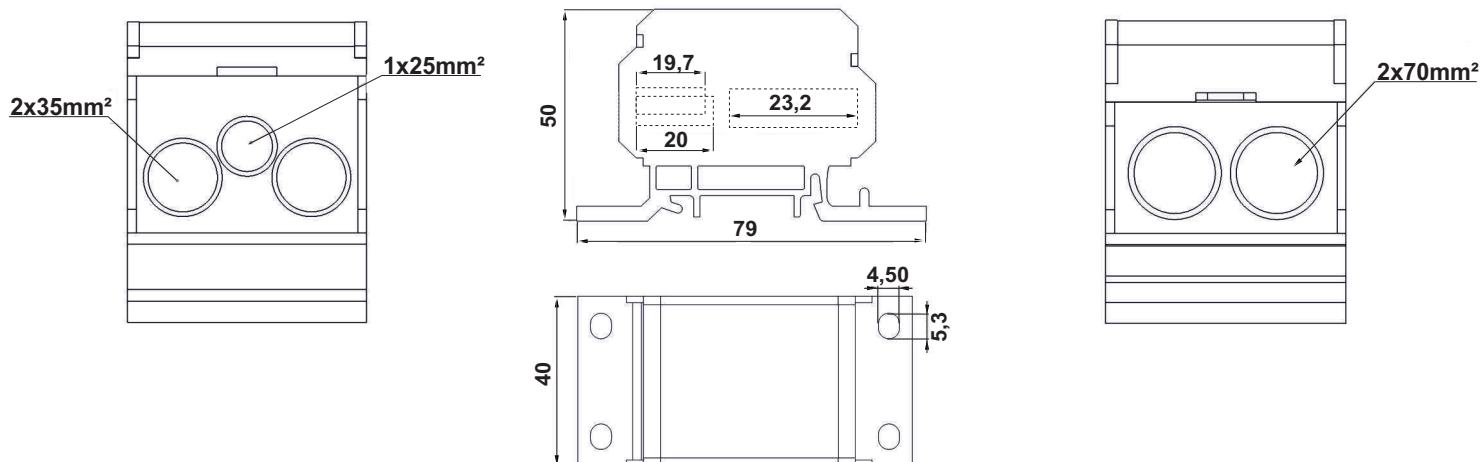





BLOK DYSTRYBUCYJNY / DISTRIBUTION BLOCK / PHASENVERTEILUNGBLOCKE
DB-6

DANE TECHNICZNE/TECHNICAL DATA/TECHNISCHE DATEN

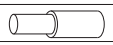
| | | |
|------------------------|--|---------------------------------|
| U_e | Napięcie znamionowe łączeniowe Nominal voltage/Bemessungsspannung | 240/415 [V] |
| U_i | Napięcie znamionowe izolacji Rated insulation voltage/Bemessungsisolatonsspannung | 1500 [V] |
| I_e | Obciążalność prądowa Max. current/ max.Schienestrom | 192 [A] |
| U_{imp} | Napięcie znamionowe udarowe wytrzymałe Surge voltage/ Bemessungsstossspannung | 12 [kV] |
| | Materiał izolacji Material of insulation/ Werkstoff für Insolierung | PA6.6 |
| | Materiał wkładu Material of insert/ elektrisches Leitermaterial | Mosiądz/ BRASS MO-58 |

| TYP TYPE TYPE | PRZEKRÓJ CROSS-SECTION QUERSCHNITT [mm ²] | DOSTĘPNE KOLORY AVAILABLE COLORS VERFUGBARE FARBEN | NUMER KATALOGOWY CATALOGUE NUMBER KATALOGNUMMER | PAKOWANIE/PACKAGING/ VERPACKUNG opak. jednostkowe/ single package/ packungseinheit [pcs]/[kg] | opak. zbiorcze/ collective packaging/ sammelverpackung [pcs]/[kg] |
|---------------------|--|--|---|--|--|
| DB-6/SZ | 70 | SZARY/GREY/GRAY | 0670235225101 | 5/1,06 | 100/21,2 |
| DB-6/N | 70 | NIEBIESKI/BLUE/BLUE | 0670235225102 | 5/1,06 | 100/21,2 |
| DB-6/ZZ | 70 | ZIELONO-ŻÓŁTY/GREEN-YELLOW/GRÜN GELD | 0670235225103 | 5/1,06 | 100/21,2 |

CHARAKTERYSTYKA GNIAZD I ZACISKÓW BLOKU /CHARACTERISTIC OF BLOCK /EIGENSCHAFTEN VON BLOCKTERMINALS

| WYJŚCIE/ EXIT/ ABGANG | | | | | | | |
|--|---|--|--|--|--|--|---|
| Pole przekroju Cross-sectional area Querschnittsfläche [mm ²] | Typ przewodu Wire type Drahtart | Przekrój przewodów Cross section of wires Querschnitt der Drähte [mm ²] | Typ śrub Screw type Art. der Schrauben | Liczba gniazd dla jednego bloku Max. connections for one block Max. Anschlüsse für einen Block | Głębokość gniazda Socket depth Sockeltiefe [mm] | Wymiar klucza ampułowego Hexagon socket, screw keys Innensechskant, Schraubenschlüssel | Max. moment dokręcający Max. torque Max. Drehmoment [Nm] |
| 25 |  | 2,5-25 | M8x8 | 1 | 19,7 | 3 | 3 |
| |  | 2,5-16 | M8x8 | | | | |
| 35 |  | 2,5-35 | M10x14 | 2 | 20 | 5 | 10 |
| |  | 4-25 | M10x14 | | | | |
| 70 |  | 4-70 | M12x14 | 2 | 23,2 | 6 | 14 |
| |  | 6-50 | M12x14 | | | | |

Quality Control:

ICE 60947-7-1